

# DENON

## RCD-M39

CD-RESSIIVER

### Kiirjuhend

Täname teid DENON CD-ressiiveri valimise eest. Käesolev juhend annab teile samm-haaval juhised CD-ressiiveri seadistamiseks.









#### Kui seadistamisega tekivad raskused...

Kui puutute seadistamisel kokku raskustega, pöörduge abi saamiseks oma piirkonna DENONi klienditeeninduse poole.

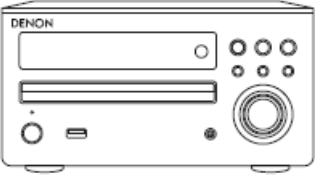

Vt karbis leiduvat aadresslehte.

### Enne, kui alustate

Mis on karbis

|  |   |  |   |
|--|---|--|---|
|  <p>Pult</p>          |  <p>R03/AAA<br/>patareid</p>   |  <p>Ainult kontinentaal-<br/>mudel</p> <p>Ainult mudelile<br/>RCD-M39DAB</p> <p>Toitejuhe</p> |   |
|  <p>CD-ressiiver</p>  |  <p>FM-siseantenn</p> <p>DAB/FM<br/>siseantenn</p> <p>Ainult kontinentaal-<br/>mudel</p> <p>Ainult mudelile<br/>RCD-M39DAB</p> |  |   |
|  <p>Ohutusjuhised</p> |  <p>Kiirjuhend</p>   |  <p>Kasutusjuhend</p>   |  <p>Hooldus-<br/>võrgustik</p> |

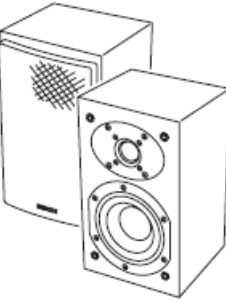
### Seadistamiseks vajalik

|  |  |
|--|--|
|  <p>Kõlar</p> |  <p>Kõlarijuhtmed</p> |
|--|--|

Pange tähele, et käesolevas juhendis toodud pildid võivad olla tegelikust seadmest erinevad.

## Seadistussammud

Seadistamine toimub viie sammuga.

1. Paigaldage patareid pulti
2. Ühendage kõlarid
3. Ühendage toitejuhe
4. Lülitage toide sisse
5. Alustage CD-plaadi taasesitamist

### 1. Paigaldage patareid pulti

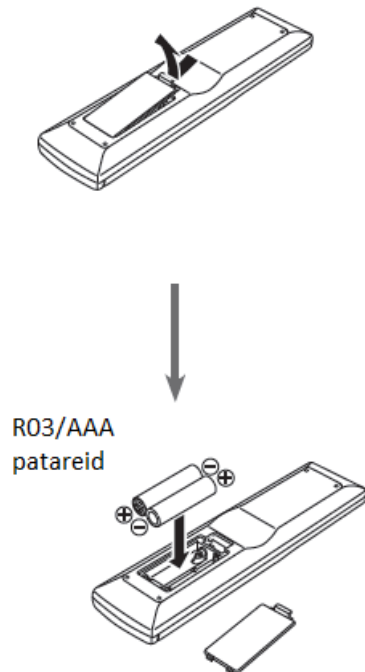

### 2. Kõlarite ühendamine

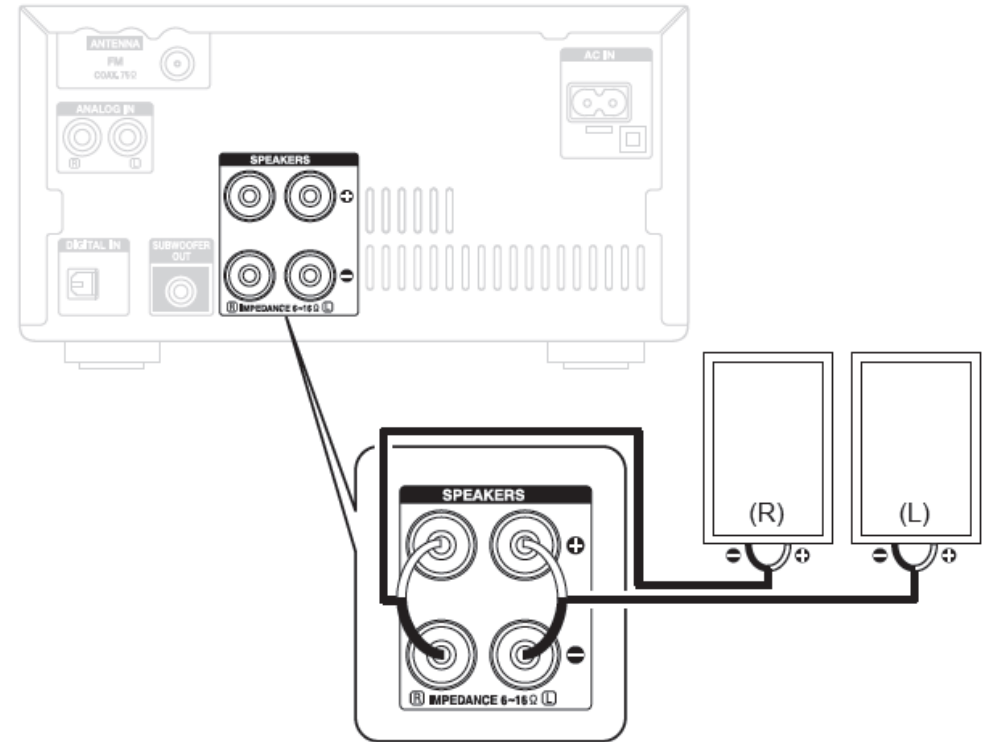

### Kõlarijuhtmete ühendamine



1. Eemaldage juhtme otsast umbes 10 mm isolatsiooni ja keerutage juhtmesooned.



2. Vabastage kõlari terminal.



3. Sisestage kõlarijuhe kõlari terminali.



4. Pingutage kõlari terminal

### 3. Ühendage toitejuhe

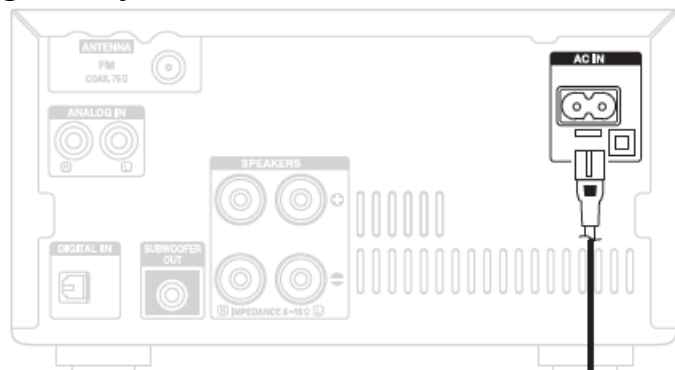

Ainult kontinantaalmodel



Ainult mudel RCD-M39DAB



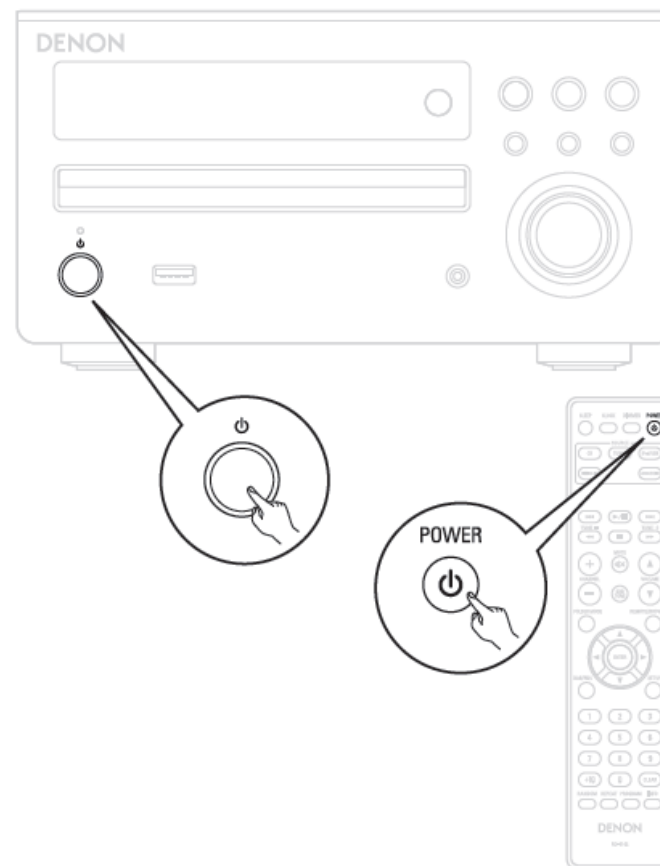

Majapidamise voluvõrgu  
pistikupesasse  
(~230 V, 50/60 Hz)

### 4. Lülitage toide sisse

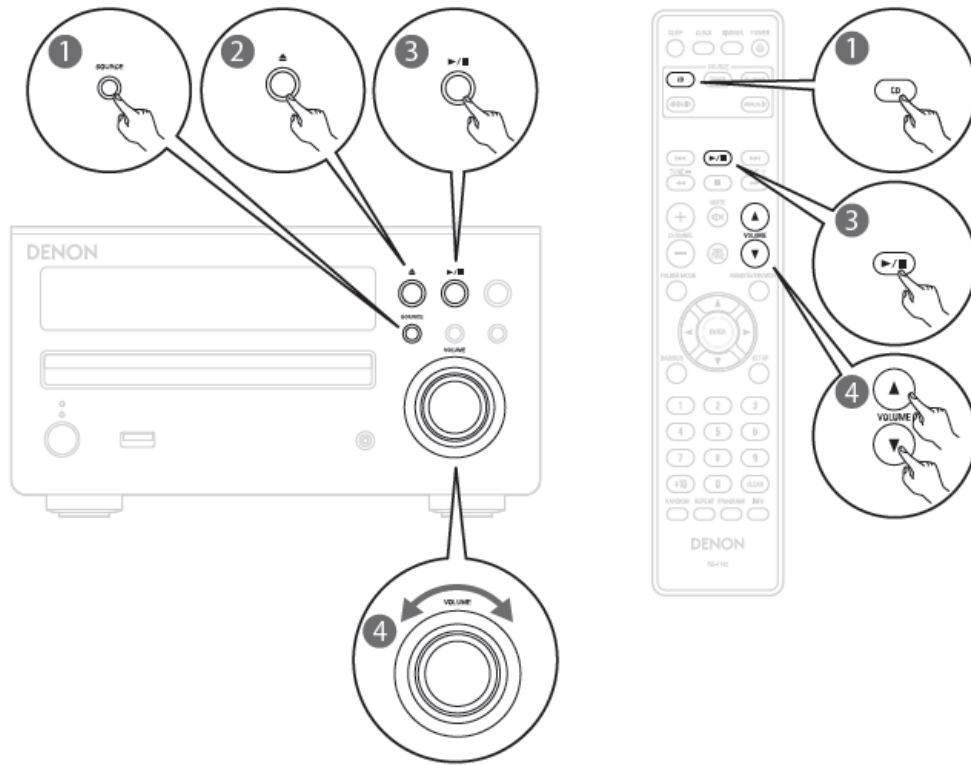

## 5. Alustage CD-plaadi taasesitamist



1. Valige sisendallikaks "CD".
2. Sisestage plaat.
3. Vajutage nuppu .
4. Reguleerige helitugevust.

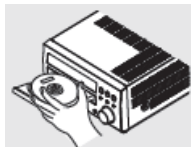

## Kasutusjuhend

Kaasasolev CD-ROM sisaldab CD-ressiiveri täielikku kasutusjuhendit Adobe PDF formaadis. Lugege nimetatud juhendist lähemalt CD-ressiiveri seadistamise, kasutamise ning võimaluste kohta.

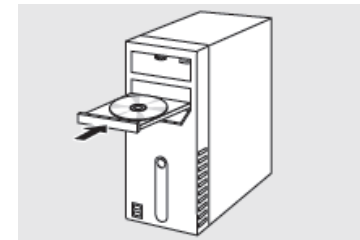

1. Sisestage plaat arvutisse.

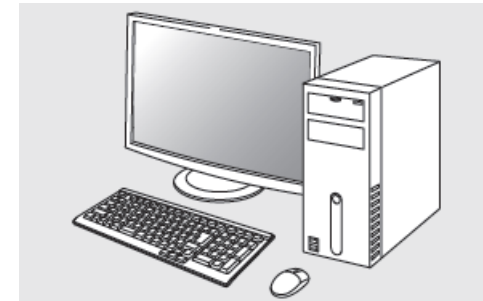

2. Järgigeekraanile kuvatud juhiseid või tehke topeltklõps PDF-failil.